

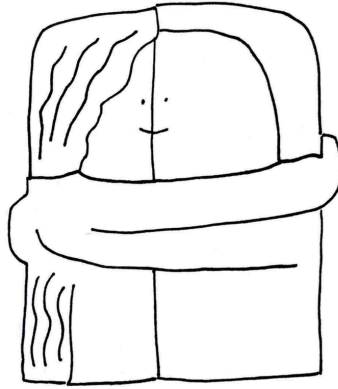

**A**

Jean (Hans) Arp,  
*Torso with Buds*



**B**

Constantin Brancusi,  
*The Kiss*

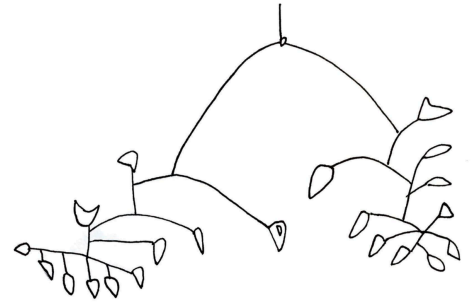

**C**

Alexander Calder,  
*10-5-4*

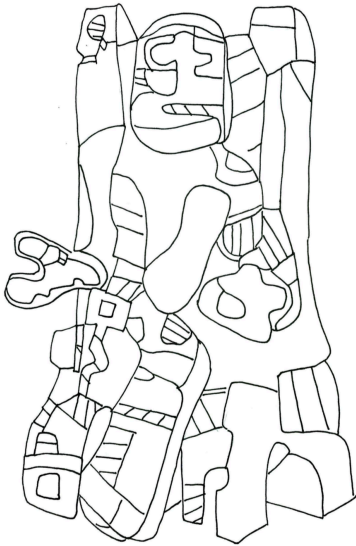

**D**

Jean Dubuffet,  
*The Gossiper II*

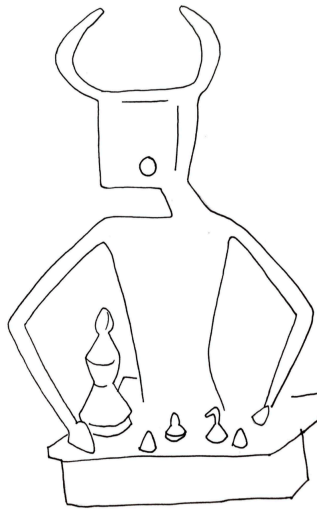

**E**

Max Ernst,  
*The King Playing with the Queen*



**F**

Frank Stella,  
*Pau*

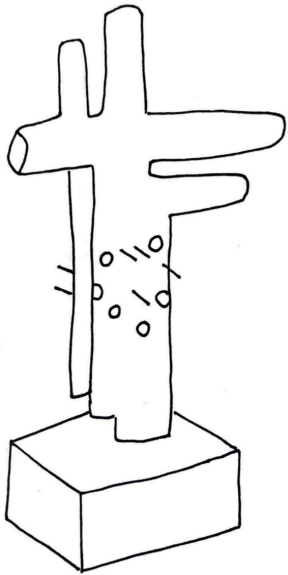

**G**

Julio González,  
*Main aux piquants*

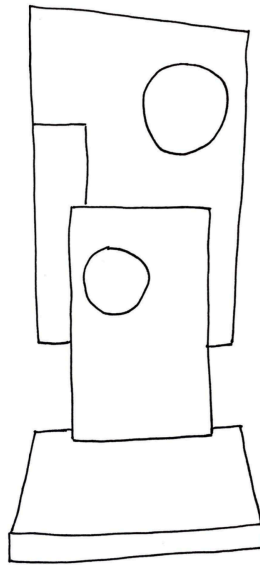

**H**

Barbara Hepworth,  
*Squares with Two Circles*  
(*Monolith*)

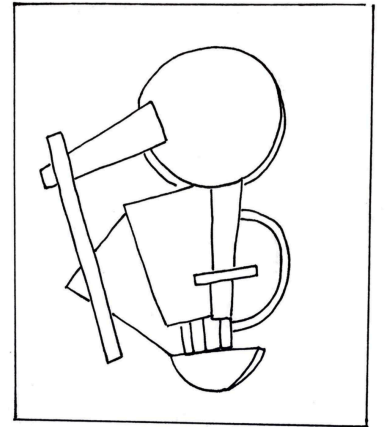

**I**

Ivan Puni,  
*Construction Relief*

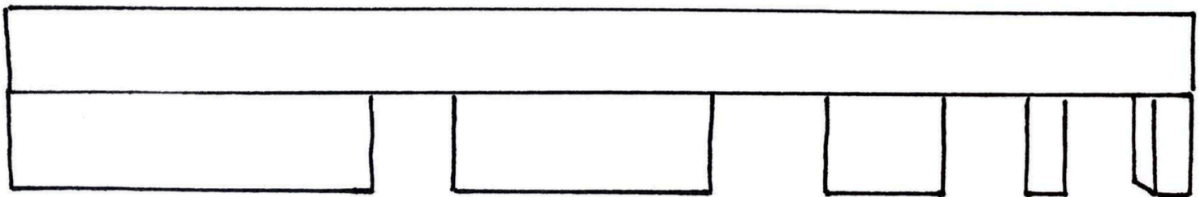

**J**

Donald Judd,  
*Untitled*



**K**

Jeff Koons  
*Louis XIV*



**L**

Roy Lichtenstein,  
*Head with Blue Shadow*

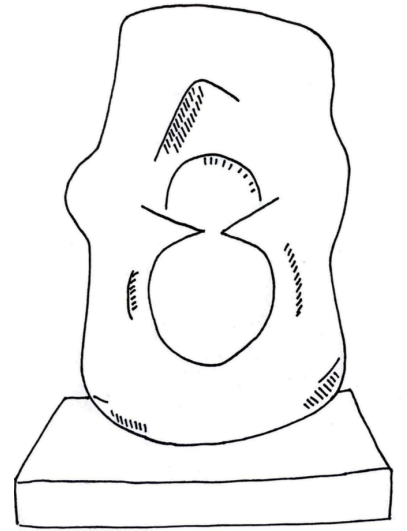

**M**

Henry Moore,  
*Working Model for Oval with Points*

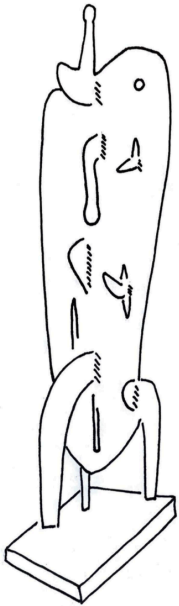

**N**

Isamu Noguchi,  
*Gregory (Effigy)*

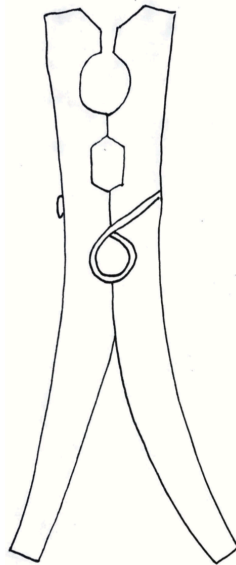

**O**

Claes Oldenburg,  
*Clothespin*

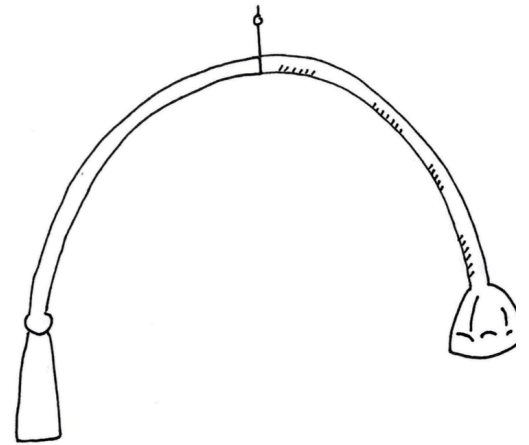

**P**

Martin Puryear,  
*Night and Day*



**Q**

Antony Gormley,  
*Quantum Cloud XX (tornado)*



**R**

Auguste Rodin,  
*Head of Balzac*

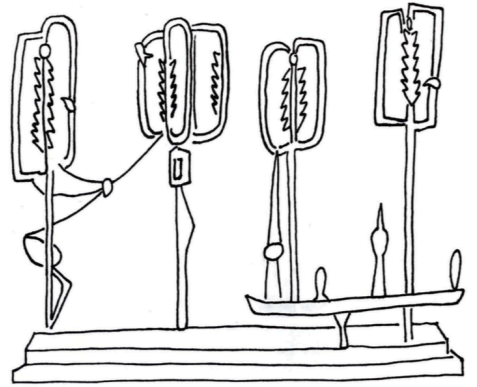

**S**

David Smith,  
*The Forest*

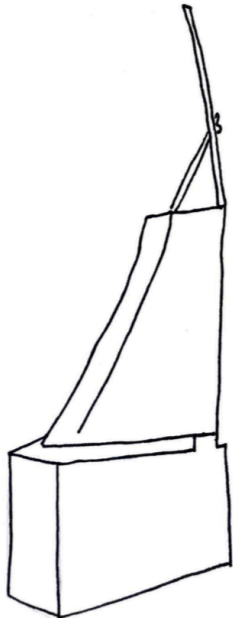

**T**

Cy Twombly,  
*Untitled*

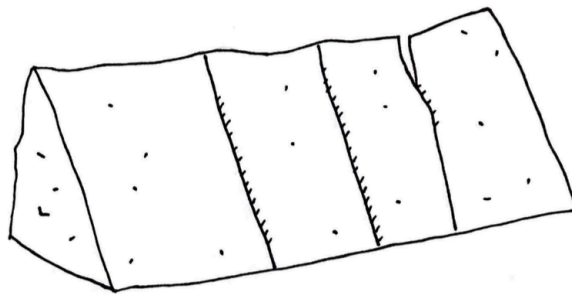

**U**

Ulrich Ruckriem,  
*Untitled (#7)*

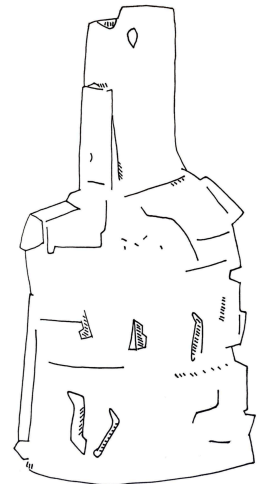

**V**

Peter Voulkos,  
*Alhambra*



**W**

Andy Warhol,  
*Portrait of Patsy Nasher*

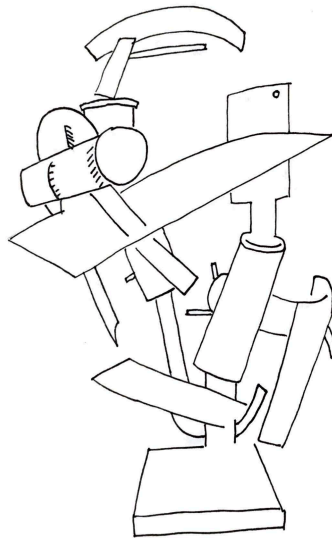

**X**

Richard Stankiewicz,  
*Untitled XXXII*



**Y**

Thomas Houseago,  
*Yet to be Titled*  
(*Peeking Figure*)

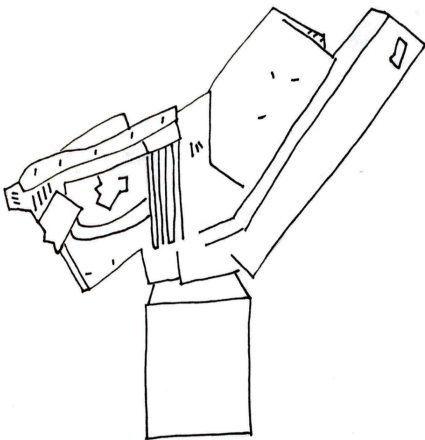

**Z**

John Chamberlain,  
*Zaar*